

XND-8
8-Port Ethernet DMX Node
User Manual

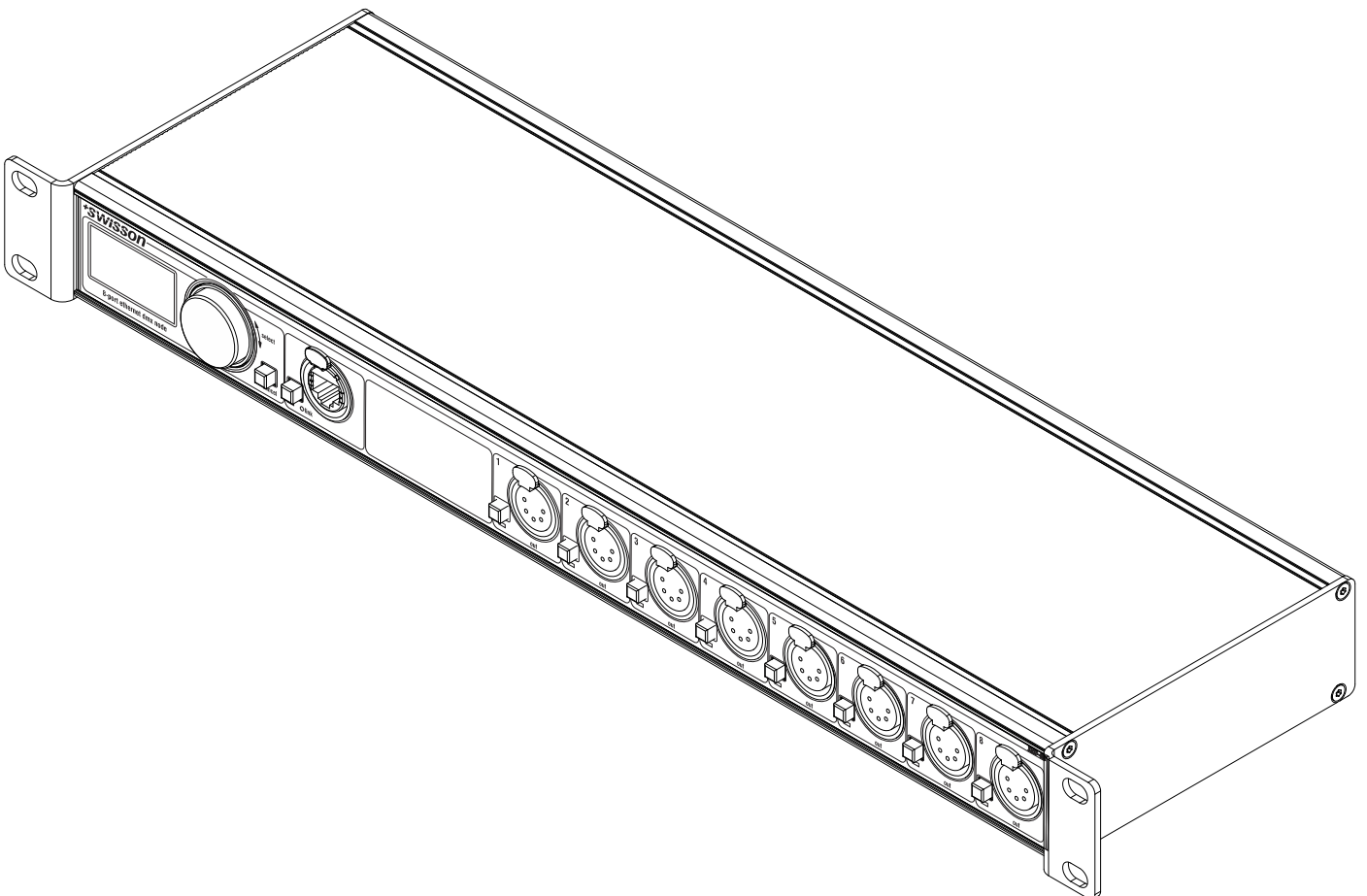

Index

Index.....	3
Introduction	4
Unpacking	4
Safety Information	4
Device Overview	6
Settings and Menu	8
Status LEDs	24
Screen Saver.....	25
Firmware Updates.....	25
Web Interface	26
Technical Data.....	28
Ordering Information.....	29
Credits	29
Appendix	30

Introduction

XND-8 is a user-friendly Art-Net and sACN to DMX converter supporting the distribution of eight universes of DMX via eight individually optically isolated DMX ports, each of which is independently configurable as an input or output. Since most major lighting consoles are capable of transmitting Art-Net data, the XND-8 is all you need to take advantage of your console's networking capability, allowing you to transmit a vast number of universes over one single network cable. In some cases, users may profit from already existing networking infrastructure.

Furthermore, the XND-8 is also perfectly suited to send DMX data to your fixtures from a computer or even from a mobile device. Many light controller programs for PC or Mac support Art-Net output natively and with the help of XND-8's DHCP capability, you can even let your workplace network infrastructure do the network configuration of your XND-8 automatically for you.

With its 128x64 pixels OLED display however, configuring the network and setting up your Art-Net or sACN preferences manually is no trouble at all and helpful status information is always at hand.

Applications

- Concert lighting
- Live events
- Multimedia shows
- Theaters
- TV studios
- Theme parks
- Architectural lighting

Typical Application

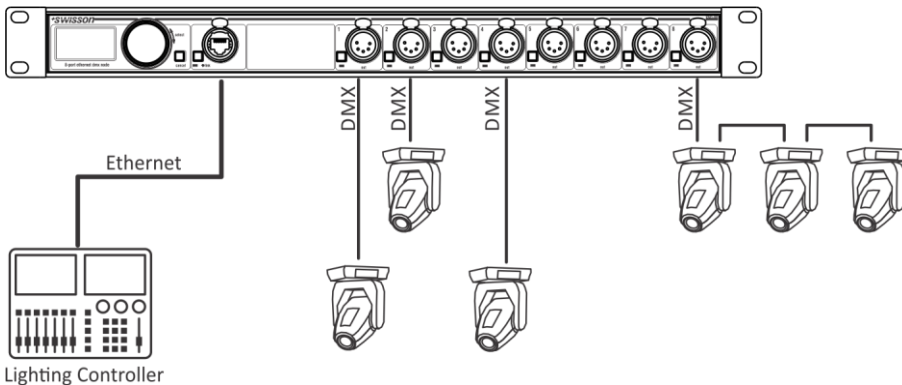

Unpacking

The XND-8 is packaged in a cardboard box. The following items are included:

- The device.
- This user manual.

Safety Information

It is essential that you read and understand this manual before operating the device and that you follow the instructions given below closely when you set up, connect and use the XND-8. Do not use the device in any way or for any purpose not described in this user manual.

This product is approved for professional use only; it is not intended for household usage. Pay attention to all warnings given in this manual and use this device only in accordance with applicable laws and regulations.

Safety Precautions

- **Disconnect the device from the AC power supply before removing any cover or part, including fuses, even when not in use.**
- **Ensure that the device is electrically connected to ground (earth).**
- **Use only a source of AC power supply that complies with local building and electrical regulations and which has both overload and ground-fault (earth fault) protection.**
- **Before using the device, check that the power distribution equipment and cables are in perfect condition and rated for the current required by all connected devices.**
- **Isolate the device from power supply immediately if the power cable or the power plugs are in any way damaged, defective or wet, or if they show signs of overheating.**
- **Do not expose the device to rain or moisture.**
- **Do not operate the device if any cover or component is missing, damaged or deformed.**
- **Refer any service operation not described in this manual to Swisson.**
- **Provide unrestricted airflow around the device.**
- **Do not operate the device if the ambient temperature exceeds 55°C (131°F).**
- **Do not modify the device in any way not described in this manual or install other than genuine Swisson parts.**
- **Do not attempt to bypass any fuse. Replace any defective fuse with one of the specified type and rating only.**
- **When suspending the device, ensure that the supporting structure and all hardware used can hold at least 10 times the weight of all devices suspended together.**
- **When suspending the device, install a secondary attachment such as a safety cable that is approved by an official body such as, e.g. TÜV (German Technical Monitoring Association), a safety attachment for the total weight it secures. The safety cable must comply with EN 60598-2-17 section 17.6.6 and be capable of bearing a static suspended load 10 times the weight of the device.**
- **Make sure that any external cover and rigging hardware is securely fastened.**
- **Provide an adequate clearance underneath the work area and a stable platform whenever installing, servicing or moving an overhead device.**
- **Do not use the device in areas where it is exposed to direct sunlight.**
- **Do not use the device in areas that are “highly inflammable”.**

Device Overview

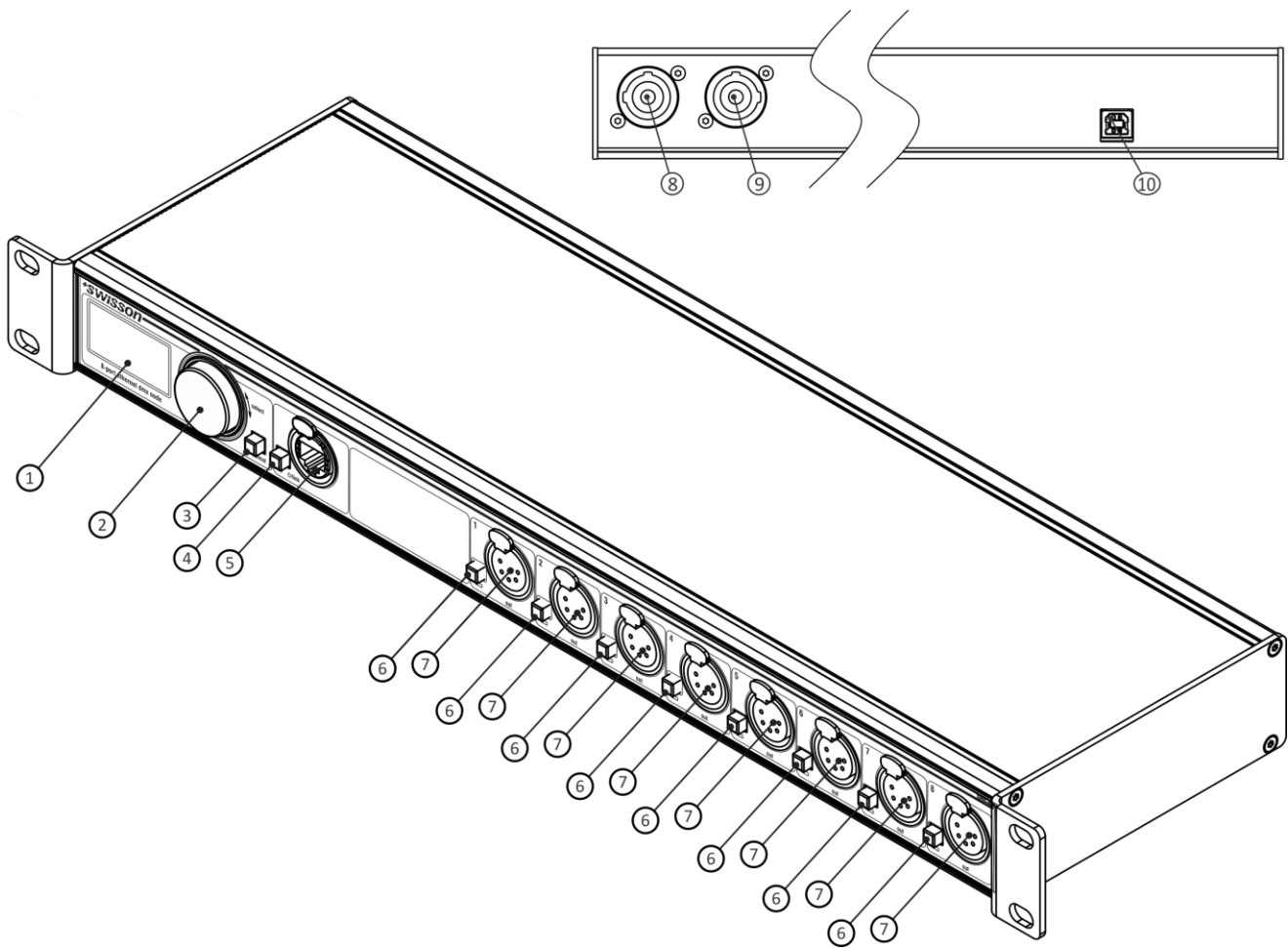

1. OLED display.
2. Encoder wheel / [OK] button. The encoder is primarily used for selecting menu items by turning the knob. It also functions as a push button. This manual refers to this button simply as [OK] button or [OK].
3. [Cancel] button.
4. Ethernet port button [E].
5. Ethernet port (RJ45 Neutrik etherCON socket).
6. Port buttons [1] - [8]. These push buttons are used to open the port menu of the corresponding port. A port status LED showing status information is located directly below each of those buttons.
7. Signal output and input ports 1 – 8.
8. Neutrik powerCON input socket.
9. Neutrik powerCON output socket.
10. USB type-B socket for firmware updates.

Mains Connection

The user must supply a suitable power cable. He may then either hard-wire the power cable to the building's electrical installation, providing an easily accessible power on/off switch close to the device, or install on the power cable a grounding-type (earthed) mains plug that is suitable for the local power outlets, following the power plug manufacturer's instructions. Consult a qualified electrician if you have any doubts about the proper installation.

A blue *Neutrik powerCON NAC3FCA* cable mount connector must be used to supply power at the XND-8's power input socket.

Warning! For protection against dangerous electrical shocks, the device must be grounded (earthed). The local AC power source must be supplied with both overload and ground-fault (earth fault) protection.

Important! Only attach or remove a Neutrik powerCON connector while it is connected to the mains to apply or cut power in an emergency, as by doing so may cause arcing at the terminals that will damage the connectors.

Power Outlet

Warning! The total current load of all devices connected to the AC mains power outlet of the XND-8 must not exceed 19.8 amperes.

- A power cable that meets the requirements specified in the safety instructions section of this manual must be used to connect the XND-8 to AC mains power and to connect other devices to the power outlet.
- A light-grey Neutrik powerCON NAC3FCB cable-mount connector must be used to draw AC mains power from the XND-8's power outlet.
- No matter what the AC mains power voltage is, the current drawn by all the devices that draw AC mains power from the power outlet of an XND-8 must not exceed a total of 19.8 amperes.

DMX Connections

Depending on the version, the XND-8 is equipped with 5-pin or 3-pin XLR connectors or with Neutrik etherCON RJ45 connectors.

XLR Connectors

Pin	Connection
1	Com
2	Data -
3	Data +
4	Not connected
5	Not connected

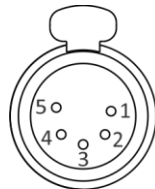

5-Pin XLR female (DMX out)

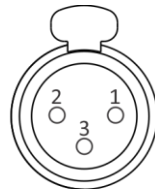

3-Pin XLR female (DMX out)

RJ45 Connectors

Pin	Connection
1	Data +
2	Data -
3	Not connected
4	Not connected
5	Not connected
6	Not connected
7	Com
8	Com
Shield	Earth

Each port is individually optically isolated.

Settings and Menu

General Navigation

The encoder wheel (see page 6) is the primary means for navigating through the menus. Most of the menus arrange items vertically. In those menus, turn the encoder clockwise to select the item below the currently selected item or turn the encoder counter clockwise to select the item above the currently selected item. In menus that arrange items horizontally (e.g. text fields), clockwise means “to the right” and counter clockwise means “to the left”.

Other than that, the encoder wheel also functions as a push button. This button is generally used to confirm a selection or to navigate to a selected submenu. This manual will also refer to pushing the encoder knob as “push [OK]” or “push the [OK] button”.

On the right side of the encoder knob, you can find the [Cancel] button (depicted on page 6), which is generally used to dismiss a selection or to exit a menu.

By keeping the [Cancel] button pressed for at least two seconds, you can always navigate to the Home Screen. From the Home Screen, the menu is launched by simply pushing the [OK] button.

The following notation is used to describe locations in the menu: *Home > Menu > Sub menu > ...*

For example, the manual could say “navigate to *Home > Menu > Art-Net*”. This can be read as follows:

Keep [Cancel] pressed for 2 seconds to reach the Home Screen.

XND-8			
ART-NET	ART-NET	ART-NET	ART-NET
0	1	2	3
ART-NET	ART-NET	ART-NET	ART-NET
4	5	6	7

Then, press [OK] to get to the menu.

MENU			
Network			
Art-Net			
Ports			
Factory Presets			
Device Settings			

Select *Art-Net* using the encoder wheel.

MENU			
Network			
Art-Net			
Ports			
Factory Presets			
Device Settings			

After pressing [OK] again to confirm the selection, a choice of the two (virtual) Art-Net nodes is displayed. XND-8 has two conceptual Art-Net nodes when the node is not operating in Art-Net 4 mode. This is because the number of Art-Net ports per node is limited to four by the Art-Net I, II and 3 specifications.

ART-NET SETTINGS			
Node 1			
Node 2			

Home Screen

XND-8			
ART-NET	ART-NET	ART-NET	ART-NET
0	1	2	3
ART-NET	ART-NET	ART-NET	ART-NET
4	5	6	7

Home Screen of an XND-8 with all ports configured to output Art-Net and addressing information displayed in decimal.

XND-8			
ART-NET	ART-NET	ART-NET	ART-NET
0	1	2	3
sACN	sACN	sACN	sACN
5	6	14	15

XND-8 Home Screen with ports 1-4 configured to output Art-Net and ports 5-8 to output sACN. Decimal universe addresses.

XND-8			
ART-NET	ART-NET	ART-NET	ART-NET
0h	1h	2h	3h
ART-NET	ART-NET	ART-NET	ART-NET
4h	5h	6h	7h

XND-8 Home Screen with ports 1-4 configured to output Art-Net and ports 5-8 as Art-Net inputs. Hexadecimal universe addresses.

The Home Screen shows the 15-bit Art-Net port address (a number between 0 and 32767) for each port configured to Art-Net, the sACN universe (a number in the range of 1 to 63999) if the port is configured to sACN or “Off” for a currently disabled port. The universe number of an input port is surrounded by a rounded corner box. A filled box around the universe number of an input port indicates the presence of a valid DMX signal. The addressing information is arranged in a table with two rows and four columns. The information of the top row (bottom row) refers to the ports 1-4 (5-8). Each cell of the table also displays the text “ART-NET” (“sACN”) if the port is configured for the Art-Net (sACN) protocol.

For detailed information on the addressing of Art-Net ports, see section Representations of Art-Net Port Addresses in the appendix.

Port Screen

The Port Screen shows information about the selected port. It can be reached by pressing the port button (button [1] – button [8], see page 6) or by navigating to *Home > Menu > Ports > Port X > Universe*. There are three variations of the Port Screen, depending on selected protocol and Art-Net version.

Output Port 2		Art-Net
DMX OK	RDM HTP	1
NET 0		
SUB 0		
UNI 1		

Art-Net 4

Output Port 2		sACN
DMX OK	RDM HTP	1
UNIVERSE		

sACN

Output Port 2		Art-Net
DMX OK		1
Net	0	
Sub-Net	0	
Sub-Uni	1	

Art-Net 3

This screen can be closed by pressing [Cancel] or [OK]. It will disappear by itself after 20 seconds. When turning the encoder, universe edit mode is activated. For more information about universe numbering and editing, see section Universe on page 14.

Depending on the port mode, the label on the top left will show if the selected port is configured as an input or as an output. A disabled port just shows the port number and a “Port Off” label.

A double tap on the port button will open a reduced port settings menu. This allows fast changes to port specific settings. See section Port Settings for more information.

Status Indication

There are several indicators and labels on the Port Screen to show the current operating mode and the state of the selected port. The following status labels displayed on the upper left of the Port Screen show the DMX signal status:

Label	Port Mode	Description
No DMX	in, out	No DMX signal present.
DMX OK	in, out	A valid DMX signal is detected.
DMX Hold	out	Port is outputting a look which has been received before, but no updates have been received for at least 10 seconds ¹ .
DMX Error	In	An error on the DMX signal appeared.

To show additional information about the selected port, there are status indicators for the presence of RDM on output ports, as well as the merge mode and status on the upper right of the display. These status indicators are only available with Art-Net 4 and sACN.

¹ 6 seconds for firmware version 0.93 and older

Indicator	Port Mode	Description
	out	Receiving signal from one source.
	out	Receiving signal from two sources. Merger active.
	out	Receiving signal from more than two sources. See section Merge Mode.
	in	Sending signal to broadcast or multicast address.
	in	Sending signal to a single unicast address. See section Input Settings.

Indicator	Port Mode	Description
	out	Art-Net RDM is enabled.
	out	Merger mode is HTP. See section Merge Mode.
	out	Merger mode is LTP. See section Merge Mode.

Network Settings

Since Art-Net I, II and 3 only support a maximum of four ports per node and require each node to have a unique IP address, XND-8 is modelled as two conceptual Art-Net nodes with two separate virtual network interfaces unless the Art-Net version is set to *Art-Net 4*. Art-Net 4 is the default setting on devices with firmware version 0.97 and later. Previous firmware versions don't support Art-Net 4.

Physically, there is only one network interface. Therefore, it is important to ensure that the settings of both network interfaces are kept compatible. This means that the settings of the two interfaces should be treated like the settings of any other two participants in the same network.

The network settings can be found under *Home > Menu > Network > Interface 1* and *Home > Menu > Network > Interface 2* if the device is running in Art-Net 3 mode, or directly under *Home > Menu > Network* if the device is running in Art-Net 4 mode with a single interface. The network settings can also be reached with a double tap of the Ethernet port button.

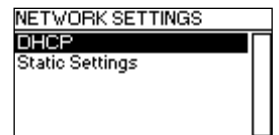

All following settings can also be changed via web interface on the Network Settings Page as seen on page 27.

DHCP

Navigate to *Home > Menu > Network > Interface N > DHCP* when the Art-Net version is set to *Art-Net 3*, or *Home > Menu > Network > DHCP* otherwise, in order to enable or disable DHCP (Dynamic Host Configuration Protocol). Choose *Enable*, if you want to have your network configured by a DHCP server. This would typically be the case, if you connect the XND-8 to a home or office network.

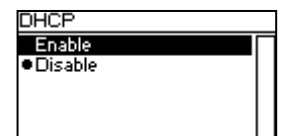

A bullet point is shown next to the currently active setting. Use the encoder wheel to choose the desired setting and confirm by pressing [OK] in order to change the setting.

Static Settings

All settings under *Home > Menu > Network > Interface N > Static Settings* (Art-Net 3 mode) or *Home > Menu > Network > Static Settings* (Art-Net 4 mode) apply only if DHCP is disabled and are ignored otherwise. From this menu, you can choose the IP address, the netmask and the gateway address to be used when DHCP is disabled.

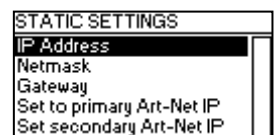

IP Address

Use this menu item to configure the device's IP address. When the IP address configuration dialog is opened, it will look just like the dialog depicted to the right. A box encircling the first number indicates that the first number is selected. While the first number (byte) of the IP address is selected, use the encoder wheel in order to choose the desired value for the first byte of the address, then push [OK] to confirm your selection. The next number will become selected allowing

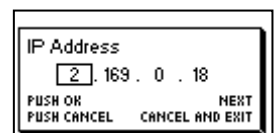

you to configure the second number. Simply repeat the same steps for the remaining numbers. After confirming the value of the last byte, the dialog will be closed, and the new settings will be applied.

Netmask

In order to configure the netmask, use the same procedure as for configuring the IP address.

The netmask is used internally to compute the network address from the IP address. XND-8 does this by computing the bitwise AND of each byte with the corresponding byte of the IP address. The bitwise AND of the first byte of the IP address and the first byte of the netmask is the first byte of the network address and so on.



Gateway

In order to configure the default gateway address, use the same procedure as for configuring the IP address or the netmask. If the network data sent by the node needs to be routed, you may want to set this address to the address of your router. In most cases however, this setting is not relevant.

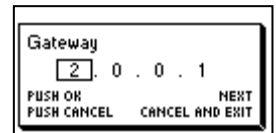

Set to Primary Art-Net IP

After navigating to the menu item *Home > Menu > Network > Interface N > Static Settings > Set to primary Art-Net IP* (Art-Net 3 mode) or *Home > Menu > Network > Static Settings > Set to primary Art-Net IP* (Art-Net 4 mode), a dialog as shown on the right will appear. Press [Cancel] to abort or press [OK] in order to apply the following settings:

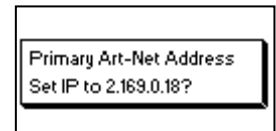

... *Static Settings > IP Address* is set to the primary Art-Net IP address (2.X.Y.Z). The values X, Y and Z are computed from the device's MAC address.

... *Static Settings > Netmask* is set to 255.0.0.0.

Set to Secondary Art-Net IP

As *Set to Primary Art-Net IP*, but sets network settings to the following values:

... *Static Settings > IP Address* is set to the secondary Art-Net IP address (10.X.Y.Z).

... *Static Settings > Netmask* is set to 255.0.0.0.

Art-Net Settings

Node wide Art-Net settings can be configured under *Home > Menu > Art-Net > Node 1* and *Home > Menu > Art-Net > Node 2* if the Art-Net version is configured to Art-Net 3 or if the firmware version is 0.96 or older.

In this case node 1 encompasses the output ports 1-4 and the virtual network interface 1, while ports 5-8 and the second virtual network interface belong to node 2.

Otherwise, if the firmware version is 0.97 or later and the Art-Net version is set to Art-Net 4, all ports belong to the same conceptual node and all node wide Art-Net settings can be found under *Home > Menu > Art-Net*.

Art-Net Version

This section applies to firmware version 0.97 and later.

The menu entry *Home > Menu > Art-Net > Art-Net Version* provides the following selection:

- *Art-Net 4*: Select Art-Net 4 to use the advantages of Art-Net 4. This is the recommended setting.
- *Art-Net 3*: Select Art-Net 3 for backward compatibility.

A bullet point is shown next to the currently active setting. Use the encoder wheel to select the desired setting and push [OK] to apply the setting.

When *Art-Net 4* is selected, each port has an independent port address in the range of 0 to 32767, which is composed of an Art-Net net, sub-net and universe number. This allows for configuring the node to any combination of Art-Net universes.

When *Art-Net 3* is active, then there are two conceptual nodes with four ports assigned to each of the nodes and all ports of the same conceptual node share their net and sub-net numbers. For more information on the addressing of the Art-Net ports, see section Representations of Art-Net Port Addresses in the appendix.

Net

This setting is only available when the Art-Net version is set to *Art-Net 3* or with firmware versions prior to version 0.97.

To adjust the Art-Net net of the node, navigate to *Home > Menu > Art-Net > Node N > Net* and adjust the number using the encoder wheel. Once the desired number has been selected, push [OK] to apply the new setting or press [Cancel] to abort.

This part of the Art-Net address was introduced with Art-Net 3. In order to work with Art-Net I and Art-Net II controllers, Art-Net net needs to be set to 0.

Note that changing this setting while independent Art-Net universes are enabled still affects all Art-Net port addresses. For more information, see Independent Universes below.

Sub-Net

This setting is only available when the Art-Net version is set to *Art-Net 3* or with firmware versions prior to version 0.97.

The sub-net is configured under *Home > Menu > Art-Net > Node N > Sub-Net* in the same way the Net is configured.

Note that changing this setting while independent Art-Net universes are enabled still affects all Art-Net port addresses of the Art-Net node. For more information, see below.

Independent Universes

This setting is only available with firmware versions that appeared before version 0.97. Newer firmware versions provide the same functionality when the Art-Net version is set to *Art-Net 4*. The main advantage of the Art-Net 4 support over the obsolete independent universes functionality is that Art-Net 4 support allows an Art-Net 4 aware controller to properly understand and, if supported by the controller, configure the port address of each port whether the ports share a common net and sub-net address or not.

Independent Art-Net universes may be enabled and disabled under *Home > Menu > Art-Net > Independent Universes*. If independent Art-Net universes are enabled, the ports of the Art-Net node do not need to share the same Art-Net net and sub-net addresses.

Independent Art-Net universes may be enabled on a per node basis and disabled under *Home > Menu > Art-Net > Node N > Independent Universes*. If independent Art-Net universes are enabled, the ports of the Art-Net node do not need to share the same Art-Net net and sub-net addresses.

When this feature is enabled, each output port has an independent port address in the range of 0 to 32767, which is computed from the Art-Net net, sub-net and universe number. This allows for configuring the node to any combination of Art-Net universes. However, if the Art-Net net or the Art-Net sub-net settings are changed (remotely or in the menu), each output port address is recomputed. For more information on the addressing of the Art-Net ports, see section Representations of Art-Net Port Addresses in the appendix.

Unfortunately, due to restrictions of Art-Net, the node may no longer correctly report the port addresses of its outputs to a controller when this feature is enabled, which might confuse a controller and lead to problems. Therefore, it is recommended to avoid enabling independent universes whenever possible.

Name

The device name can be viewed and edited under *Home > Menu > Settings > Art-Net > Name* if the Art-Net version is set to Art-Net 4. Otherwise, the name can be set for each conceptual node instance separately under *Home > Menu > Settings > Art-Net > Node 1 > Name* and *Home > Menu > Settings > Art-Net > Node 2 > Name*.

Deleting Text

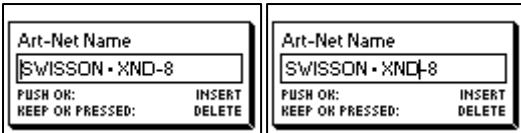

To delete a text line or a part of it, position the cursor immediately to the left of the first character you want to have deleted.

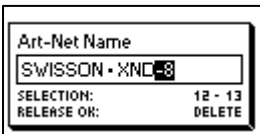

Then keep [OK] pressed and turn the encoder clockwise until all of the text that you wish to delete appears highlighted.

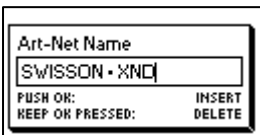

As you release the [OK] button, the highlighted text is removed.

Inserting or Appending Text

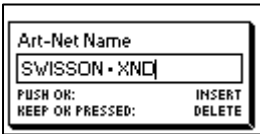

To append or insert text, move the cursor to the position where you want to add your text.

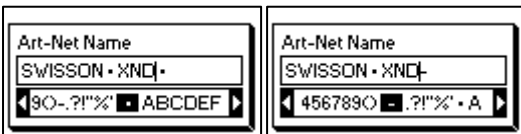

Then push the [OK] button and select a character to add.



Confirm your selection by pressing [OK].

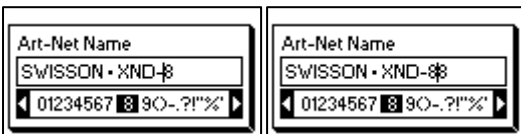

Repeat the above steps for the remaining characters. Then, press [Cancel] to finish inserting characters.

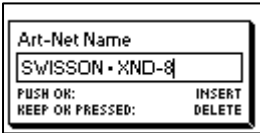

Press [Cancel] again to quit the editor.

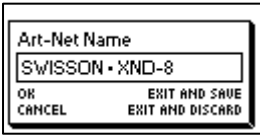

Press [OK] to store the changes or press [Cancel] to discard all changes.

Short Name

The short name can be viewed and edited under *Home > Menu > Art-Net > Short Name* (Art-Net 4 mode) or *Home > Menu > Art-Net > Node 1 > Short Name* and *Menu > Art-Net > Node 2 > Short Name* (Art-Net 3 mode). Editing the short name is done in the same way the name is edited.

Port Settings

For each port, there is a settings menu under *Home > Menu > Ports > Port [1-8]*. E.g. the menu for port 1 is under *Home > Menu > Ports > Port 1*. The port settings menu contains the items described below. When opening this screen with a double tap to the port button (button [1] – button [8], see page 6) this menu is shown as a reduced version with only the options required for configuring the current mode.

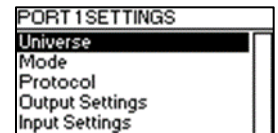

Universe

To adjust the universe of port X, navigate to *Home > Menu > Ports > Port X > Universe*. This screen can also be reached by pressing the corresponding port button once.

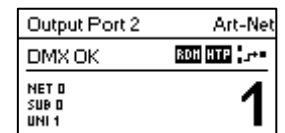

This screen provides essential information about the DMX port and allows for changing its Art-Net or sACN universe. For more information about the indicators on this screen, see section Port Screen on page 9.

Use the encoder wheel for changing the universe of the given port. Once the desired universe appears on the screen, push OK to use this universe or press cancel to revert to the previously configured universe.

Art-Net (Version 4)

This section describes the universe configuration screen of ports that are in Art-Net mode while the Art-Net version is set to *Art-Net 4*.

The port address is the large number on the bottom of the display. While it is being edited, a slowly blinking cursor is shown below the currently editable digit. Use the encoder to increase or decrease that digit. Push the port button corresponding to the port that is being edited to change the digit that is currently editable. Firmware versions 0.97 and later also display the Art-Net net, the Art-Net sub-net and the Art-Net universe part of the port address on the lower half of the display near the left edge.

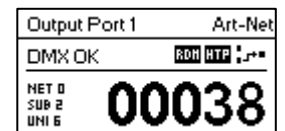

If an input port is configured for Art-Net 4, data is transmitted to the directed broadcast IP address (e.g. 2.255.255.255).

For more information about the addressing of Art-Net ports, see section Representations of Art-Net Port Addresses in the appendix.

Art-Net (Version 3)

This section describes the screen for editing the universe of a port running in Art-Net mode when the Art-Net version is set to *Art-Net 3*.

The screen looks the same on devices with a firmware older than version 0.97 if the corresponding port is in Art-Net mode and independent universes are disabled. Consult page 12 for details about the independent universes feature.

Please note that while the universe (large number on the right-hand side of the display) is being edited but has not yet been stored, its background lights up and the number is displayed in its inverted colour about once every second. If that is the case and you just want to see the configured universe number, simply press [Cancel].

Output Port 1	Art-Net
No DMX	UNIVERSE
Net	0
Sub-Net	0
Sub-Uni	5

On the left-hand side of the screen, the following information is displayed on three lines below the status label (see section Status Indication on page 9): Art-Net net, Art-Net sub-net and Art-Net sub-uni.

The Art-Net sub-uni is computed from the sub-net and the universe of a port as $16 \times \text{sub-net} + \text{universe}$. Some controllers address the Art-Net universe as a single number in the range of 0 to 255. Sub-uni corresponds to that number.

If an input port is configured for Art-Net 3, data is transmitted to the directed broadcast IP address (e.g. 2.255.255.255).

sACN

Ports that are running in sACN mode display the sACN universe number and status indicators.

The sACN universe number may be in the range of 1 – 63999. While the universe (large number at the bottom) is being edited but has not yet been stored, a slowly blinking cursor is shown below the currently editable digit. Use the encoder to increase or decrease that digit. Push the port button corresponding to the port that is being edited to change the digit that is currently editable.

Output Port 1	sACN
No DMX	RDH HTP
UNIVERSE	00005

If an input port is configured for sACN, data is transmitted to the sACN multicast IP address of the respective universe (e.g. 239.255.0.1 for universe 1).

Mode

Under *Mode*, a selection list is presented to you with the following options:

- *Output*: The port outputs data received from the network.
- *Input*¹: The port is configured as DMX input and sends data to the network.
- *Off*: The port is turned off.

A bullet point is shown next to the currently active setting. Use the encoder wheel to select the desired setting and push [OK] to apply the setting.

When setting multiple inputs to the same universe, the node will output the data depending on the used protocol:

- Art-Net: Only one port will send data to the network, because Art-Net streams are identified by the IP address.
- sACN: All inputs can send data to the network, because sACN identifies every stream with an own ID.

Protocol

Under *Protocol*, you can choose between the following two options:

- *Art-Net*: The port is using the Art-Net protocol for either input or output mode.

¹ Available only on Firmware 0.98 and newer

- **sACN**: The port is using the sACN protocol for either input or output mode.

A bullet point is shown next to the currently active setting. Use the encoder wheel to select the desired setting and push [OK] to apply the setting.

Output Settings

DMX Output Mode

The *DMX Output Mode* menu allows for choosing the DMX timing. This menu item has been introduced with firmware version 0.95. Currently the following choices are available:

- *Max. Frame Rate (44 Hz)*
- *Relaxed (30 Hz)*

When **Max. Frame Rate** is selected, the DMX output signal has the following properties:

- Refresh rate: Ca. 44 Hz when 512 channels are being sent, depending on the amount of RDM requests sent from the controller and further reduced during RDM discovery.
- Break length: Ca. 180 μ S.
- Mark after break: Ca. 40 μ S.

The *DMX Output Mode Relaxed* has the following behaviour:

- Refresh rate: Ca. 30 Hz when 512 channels are being sent, depending on the amount of RDM requests sent from the controller and further reduced during RDM discovery.
- Break length: Ca. 300 μ S.
- Mark after break: Ca. 80 μ S.
- A small delay of about 20 μ S is inserted between slots to reduce the update rate. This may reduce problems such as flickering when legacy fixtures are in use.

Merge Mode

Under *Merge Mode*, a selection list is presented to you with the following options:

- *HTP*: Highest takes precedence. If for a given DMX channel data has been received from two sources, the higher value is used.
- *LTP*: Latest takes precedence. If for a given DMX channel data has been received from two sources, LTP merging uses the value of whichever source was the last to change the value it has sent for that given channel.
- *Off*: Merging is disabled.

Merging is applied when two Art-Net or sACN controllers send data for the same port. If more than two controllers send data for the same port, the following rules take effect:

- **Art-Net**: The first two appeared data streams are merged. All following ones are discarded.
- **sACN**: The first two streams with the same priority are merged. Further streams of the same or lower priority are discarded. If a stream with higher priority appears, the lower priority ones will be discarded.

A bullet point is shown next to the currently active setting. Use the encoder wheel to select the desired setting and push [OK], to apply the setting.

Failure Behaviour

Under *Failure Behaviour*, a selection list is presented to you with the following options:

- *Off*: The output will stop sending DMX, after no updates for the universe of the output have been received for 10 seconds¹.
- *Hold Last Look*: The output will continue to send the last look even if no updates are received.

A bullet point is shown next to the currently active setting. Use the encoder wheel to select the desired setting and push [OK] to apply the setting.

Art-Net RDM

Under *Art-Net RDM*, RDM may be enabled or disabled for the output. Art-Net RDM can also be enabled for sACN ports. XND-8 discovers a maximum of 250 devices per output port.

All the previously described settings can be changed via web interface on the Port Settings Page from page 26.

Auto Universe Label

This menu is only shown when *Art-Net RDM* is enabled. Auto Universe Label is a functionality to automatically show the universe number of an XND-8 port on the display of connected Swissson devices supporting this. When enabled, the universe number is transmitted every two seconds with a small standard compliant RDM packet. Therefore, the labels are only present on output ports with *Art-Net RDM* enabled. Auto Universe Label RDM packets are transmitted as so called vendorcast messages and are ignored by every standard compliant DMX and RDM receiver not manufactured by Swissson.

The following depiction shows an example setup using the Auto Universe Label feature.

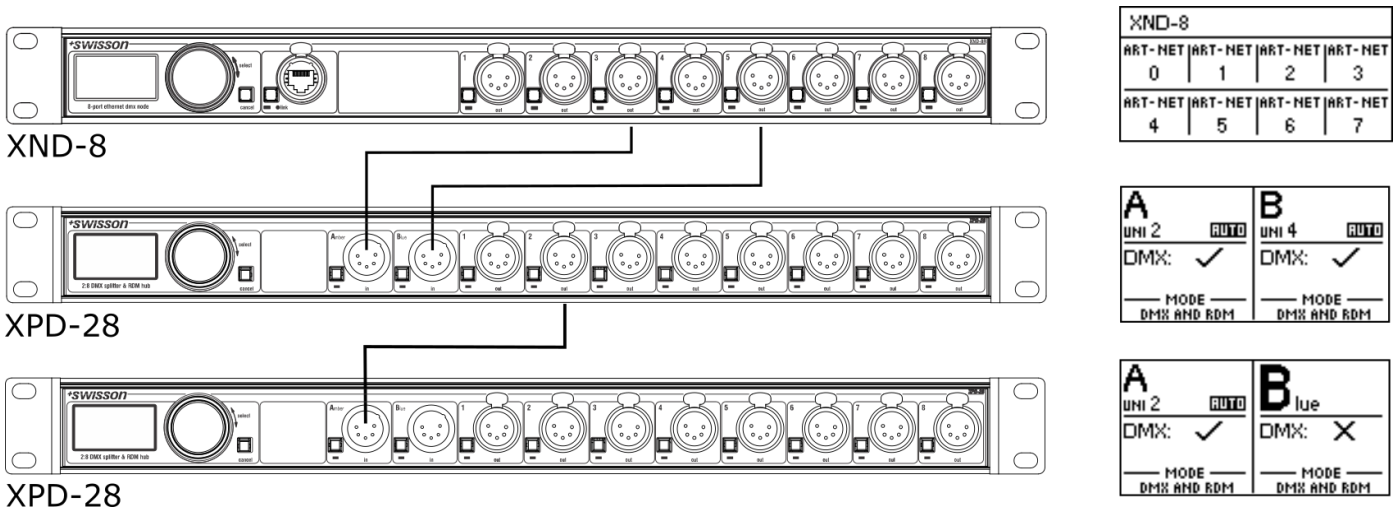

Input Settings²

Transmit Mode

Under *Transmit Mode*, the transmission behaviour of an Art-Net or sACN Packet can be configured with two options:

- *Broadcast/Multicast*: DMX data applied to the input port is transmitted to the directed broadcast IP address (multicast for sACN). Every reachable device in the same subnet can receive the data.
- *Unicast*: DMX data applied to the input port is transmitted to a unicast IP address set by the user. Only one network device with matching IP address can receive the data.

¹ For firmware versions 0.93 and older: 6 seconds
² Available only on firmware version 1.01 and newer

Destination IP

This menu only appears when the *Transmit Mode* is set to *Unicast*. After opening the menu, an IP address edit window is shown. This window allows the setting of a single unicast destination IP address, similar to the IP address edit windows in section *Network Settings*.

Local Forwarding

This menu only appears when the *Transmit Mode* is set to *Unicast* and allows to enable or disable the forwarding of DMX data to the local ports of the node. If *Transmit Mode* is set to *Broadcast/Multicast*, the data is always forwarded.

- *Enabled*: DMX data applied to an input port is forwarded to local DMX outputs of this node, if universe and protocol of the output port is matching with the input port.
- *Disabled*: DMX data is only transmitted to the configured unicast IP address and not present on local output ports of this node.

Factory Presets

Firmware Version 1.00

The *Factory Presets* menu entry of the main menu allows you to load one of the following factory defined presets on devices with firmware version 1.00 or newer:

- Art-Net:
 - Art-Net RDM is enabled on all ports.
 - All ports are configured as outputs.
 - Ports 1 – 8 are configured to consecutive Art-Net universes (port addresses). The user is asked to choose a start universe.
 - The user is prompted by a separate dialog to choose whether to adjust the network settings. If he chooses to do so, the IP address is set to the primary Art-Net IP address and the netmask is set to 255.0.0.0.
- Art-Net, no RDM:
 - Same as Art-Net, RDM disabled on all ports.
- sACN:
 - All ports are configured as outputs.
 - Network settings remain unchanged.
 - Art-Net RDM is enabled.
 - Ports 1 – 8 are configured to consecutive sACN universes. The user is asked to choose a start universe.
- sACN, no RDM:
 - Same as sACN, Art-Net RDM disabled on all ports.
- 1– 4: Art-Net – 5– 8: sACN:
 - Art-Net RDM is enabled on all ports.
 - All ports are configured as outputs.
 - Ports 1 through 4 are configured to Art-Net.
 - Ports 5 through 8 are configured to sACN.
 - The ports are configured to consecutive universes (port addresses). The user is asked to choose a start universe.

- The user is prompted by a separate dialog to choose whether to adjust the network settings. If he chooses to do so, the IP address is set to the primary Art-Net IP address and the netmask is set to 255.0.0.0.
- Art-Net, Office Network:
 - Same as Art-Net but network is configured via DHCP.

Firmware Version 0.96 and Older

The *Factory Presets* menu entry of the main menu allows you to load one of the following factory defined presets on devices with firmware versions released prior to version 0.97 (version 0.96 and older):

- Art-Net:
 - Loads default network settings (IP addresses set to primary Art-Net IP addresses).
 - Art-Net RDM is enabled on all ports.
 - Ports 1 – 8 are configured to Art-Net universes 0 – 7 (Art-Net sub-net: 0, Art-Net net: 0).
- Art-Net, no RDM:
 - Same as Art-Net, RDM disabled on all ports.
- sACN:
 - Network is configured via DHCP.
 - Art-Net RDM is enabled.
 - Ports 1 – 8 are configured to sACN universes 1– 8.
- 1– 4: Art-Net – 5– 8: sACN:
 - Loads default network settings (IP addresses set to primary Art-Net IP addresses).
 - Art-Net RDM is enabled on all ports. Note: affects port 1 through 4 only, while port 5 – 8 are configured to output data from sACN.
 - Ports 1 – 4 are configured to Art-Net universe 0 – 3 (Art-Net sub-net: 0, Art-Net net: 0).
 - Ports 5 – 8 are configured to sACN universe 5 – 8.
- Art-Net, Office Network:
 - Same as Art-Net but network is configured via DHCP.

Loading any of the presets disables independent Art-Net universes (Independent Universes, page 12).

Device Settings and Information

Address Display Mode

Under *Address Display Mode*, a selection list is presented to you with the following options:

- *Decimal*: Art-Net net, Art-Net sub-net, Art-Net or sACN universe and Art-Net sub-uni are displayed as decimal numbers.
- *Hexadecimal*: Art-Net net, Art-Net sub-net, Art-Net or sACN universe and Art-Net sub-uni are presented as hexadecimal numbers with a trailing h (e.g. F3h).

A bullet point is shown next to the currently active setting. Use the encoder wheel to select the desired setting and push [OK], to apply the setting.

Web Interface

Under *Web Interface*, a selection list is presented to you with the following options:

- *Enable*: The web interface is enabled.
- *Disable*: The web interface is disabled.

A bullet point is shown next to the currently active setting. Use the encoder wheel to select the desired setting and push [OK] to apply the setting. Changing this setting, requires a restart of the node. A popup will ask for confirmation. Press [OK] to restart now or [Cancel] to abort.

This option of the device settings is only available as of firmware version 1.00. Further information can be found on page 26.

Screen Saver

Under *Screen Saver*, a selection list is presented to you with the following options:

- *Enable*: Screen saver is enabled.
- *Disable*: Screen saver is disabled.

A bullet point is shown next to the currently active setting. Use the encoder wheel to select the desired setting and push [OK] to apply the setting.

Please refer to the section Screen Saver on page 25 for more details about the behaviour of the screen saver.

Mute LEDs

Under *Mute LEDs*, a selection list is presented to you with the following options:

- *Mute*: All status indicator LEDs of the device remain dark regardless of the device's status.
- *Unmute*: The status indicator LEDs behave as described under Status LEDs on page 24.

A bullet point is shown next to the currently active setting. Use the encoder wheel to select the desired setting and push [OK] in order to apply the setting.

All previously listed device settings can be changed via the web interface on the Device Settings Page as described on page 27.

User Input Locking

The menu item *User Input Locking* allows you to lock your device with a password to protect your device from unauthorized or accidental manipulation. Alternatively, the device may also be locked without a password in order to just prevent accidental manipulation. For details see Simple Locking on page 21.

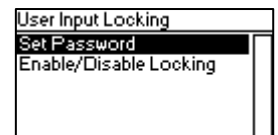

When the device is locked, the user will only be able to see the Home Screen (see page 8) and the Ethernet Port Status Information (see page 24). Since the menu is unavailable while the device is locked, the is only accessible via the Ethernet port button [E].

When pressing the [OK] button from the Home Screen of a locked device, it will prompt for the password. If it is entered correctly, the device becomes unlocked and the main menu is displayed. A padlock symbol in the top right corner of the Home Screen indicates that the user input is currently locked.

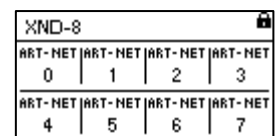

Before a device can be locked, a password must be set, and locking must be enabled.

Set Password

Choose the menu entry *Settings > User Input Locking > Set Password* to set a password. A dialog will show up that prompts for a password. Password editing works just like editing the device name, as detailed on page 13.

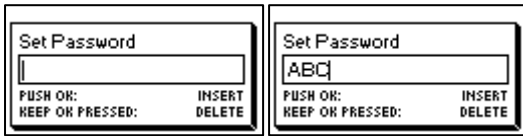

Once the password has been entered, XND-8 will ask you to enter the password a second time.

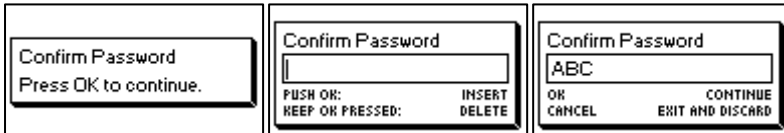

If the two entered texts match, the password is set.

Finally, after the password was successfully stored, the user will be asked whether he wants to enable password locking, if it is not already enabled.

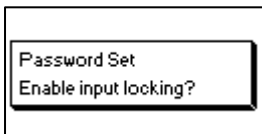

By pressing [OK], password locking is enabled. Pressing [Cancel] closes the dialog and keeps password locking disabled, but the password is set anyway.

To change the password, simply open the *Set Password* dialog again. It is not required to enter the current password before changing it.

Enable/Disable Locking

The menu entry *Settings > User Input Locking > Enable/Disable Locking* lets the user choose whether password locking is disabled or enabled.

Password Locking

If the user requests to enable password locking and a password has already been set, the user will be asked to enter the password before password locking is enabled. If the user requests to enable password locking when no password has been set up, the user will be prompted to enter and confirm a password, before password locking is enabled.

Simple Locking

Simple locking can be enabled whether a password has been set or not. When simple locking is used, the user will be asked to press [Cancel] three times within 3 seconds when attempting to unlock the device by pressing the [OK] button from the home screen.

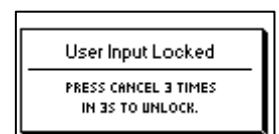

Lock User Input

Once password locking has been enabled, the additional menu item *Lock User Input* will appear on the top level of the menu and under *Home > Menu > Settings > User Input Locking*. If the user activates this menu item, he will be asked whether the device should be locked. [OK] will lock the device, [Cancel] will keep it unlocked.

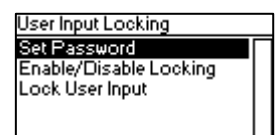

The device will also be locked when the screen saver becomes active or after a power cycle if locking has been enabled.

Device Information

The following information about the device is available under *Home > Menu > Device Settings > Device Information*.

Model

The device model is reported as “XND-8” for all variants of the XND-8.

Boot Software

The full version number of the boot software.

Firmware

The full version number of the firmware.

Hardware

The hardware revision.

MAC Addresses

The MAC address of the node’s Ethernet interfaces.

UIDs

The RDM UIDs (unique identifiers) of the eight output ports. These are numbers that unambiguously identify any RDM device. Since each output port may act as an RDM controller, each output port has assigned its own RDM UID.

Restore Default Settings

The default settings can be restored under *Home > Menu > Restore Default Settings*. In this menu, you will be asked whether you want to continue restoring all settings. Push [OK] to confirm or [Cancel] to abort.

The default settings can also be restored from the Device Settings Page of the web interface as described on page 27.

This function will restore all settings to the defaults:

- Name (Art-Net node 1 and 2): SWISSON XND-8
- Short name (Art-Net node 1 and 2): XND-8
- Art-Net net (Art-Net node 1 and 2): 0
- Art-Net sub-net (Art-Net node 1 and 2): 0
- Art-Net RDM: Disabled on all output ports¹
- Auto universe label: Enabled²
- Independent universes: Disabled³
- Art-Net version: Art-Net 4⁴
- All outputs enabled
- DMX output mode (all ports): Relaxed⁵
- Art-Net universe output 1-8: 0-7
- Failure behaviour (all outputs): Hold last look
- Merge mode (all outputs): HTP
- Input transmit mode: Broadcast/Multicast²
- Input destination IP: 127.0.0.1²
- Input local forwarding: Enabled²
- IP addresses: 2.X.Y.Z (primary Art-Net IP addresses)
- Netmask (both interfaces): 255.0.0.0
- Address display mode: Decimal
- LEDs: Unmuted
- Screen saver: Disabled⁶
- User input locking: Disabled, password not set
- Web interface: Enabled⁷

¹ For firmware versions 0.99 and older: RDM enabled

² Available only on firmware version 1.01 and newer

³ Available only on firmware version 0.96 and older

⁴ Available only on firmware version 0.97 and newer

⁵ For firmware versions 0.95 and 0.96: Max. frame rate

⁶ For firmware versions 1.00 and older: Screen saver enabled

⁷ Available only on firmware version 1.00 and newer

Ethernet Port Status Information

This screen is reached by pressing the Ethernet port button [E], which is located right next to the Ethernet port. See Device Overview on page 6 for more precise information about the location of this button.

Ethernet	
Link Up	100 Mb/s
Duplex	Full
IP Address	2.169.0.18
Netmask	255.0.0.0

This screen shows the following information about the status of the Ethernet port on four lines:

- The first line below the title shows whether the link is up or down and what the current connection speed is (10 Mb/s or 100 Mb/s).
- The next line informs whether the link is full or half duplex if a link is established.
- The last two lines display the currently configured IP address and the currently configured netmask.

When the Art-Net version is set to *Art-Net 3* or if the firmware is version 0.96 or lower, the node has two virtual interfaces. Use the encoder knob or push the Ethernet port button [E] again to change for which of the two virtual interfaces the IP address and the netmask is displayed.

Ethernet	Interface 1 of 2
Link Up	100 Mb/s
Duplex	Full
IP Address	2.169.2.3
Netmask	255.0.0.0

While the information on the first two lines concerns the physical Ethernet interface, the IP address and the netmask may differ between the two virtual interfaces of the XND-8.

Ethernet	Interface 2 of 2
Link Up	100 Mb/s
Duplex	Full
IP Address	2.169.2.4
Netmask	255.0.0.0

Status LEDs

All LEDs can be muted, in which case they stay dark independently of the device's status. The information below applies when the LEDs are not muted (unmuted). Please refer to Mute LEDs on page 20 for more information about muting and unmuting the LEDs.

Selected Port

When a port is selected, the port's status LED flashes in white for 0.1 seconds once every 0.2 seconds. The DMX ports and the Ethernet port can be selected using the push button next to the port. Further, the DMX ports can also be selected via the menu (*Home > Menu > Outputs > Output [1-8] > Universe*).

Not Selected DMX Port

If a DMX port is not selected, the port's status LED provides the following information. It shows the port status for at least 0.7 seconds every second using the following colour coding:

- Output port:
 - Red: Not sending DMX data, but the port is enabled.
 - Yellow: Sending last look but did not receive an update for at least 10 seconds⁷
 - Green: Sending DMX data, receiving updates.
- Input port
 - Blue flashing: No DMX signal detected.
 - Blue static: DMX signal is present and valid.
 - Red: DMX signal error.
- Disabled port:
 - Black: Port is disabled / turned off.

⁷ For firmware versions 0.93 and older: 6 seconds

The LED lights up white for 0.3 seconds every second, if the node is set *identified*.

Ethernet Port (Not Selected)

The status LED lights up for 0.3 seconds every second, if the node is set *identified*.

On the right-hand side of the status LED, there is also a link LED, which lights up in green, if an Ethernet link has been established. Traffic is indicated by short interruptions.

Identify

The XND-8 can help the user to locate the device under certain conditions through the identify process. The node can be set in an identified state, by means of communication, like Art-Net, RDM or the web interface. In the case of the XND-8 the identified device will light up all port status LEDs white, for 0.3 seconds every second, for as long as the device is set identified.

Screen Saver

The OLED display will automatically turn itself off when no user input is received for 40 seconds in order to improve the durability of the product, if the screen saver is enabled. Once the display is turned off, it can be turned on again by pushing any button or by turning the encoder wheel by one unit in any direction.

The screen saver can be enabled or disabled under *Home > Menu > Device Settings > Screen Saver*, as described under Screen Saver on page 20.

Firmware Updates

Firmware updates will be provided on the product page on the Swisson website. For updating the firmware, a PC with Windows (Vista or later) and a USB A to B cable (USB printer cable) is required. Please refer to the separate documentation also provided on the product web page for details about the process of updating the product's firmware.

Alternatively, firmware updates can be done via web interface on the Firmware Update Page as described on page 27.

Web Interface

As of firmware version 1.00 the XND-8 allows the use of a web interface hosted by the device. Through this interface the status may be observed, settings can be adjusted, and firmware updates can be carried out. The web interface is accessed by typing the devices configured IP address in a web browser of a computer, that is connected to the same network as the XND-8.

Status Page

The status page is the first to welcome the user after accessing the web interface. It lets the user get an overview over every individual port's status and configuration at a quick glance. In addition to the overview a toggle switch can be enabled to set the device identified.

The ports can display five different status messages, like the ones described on page 9:

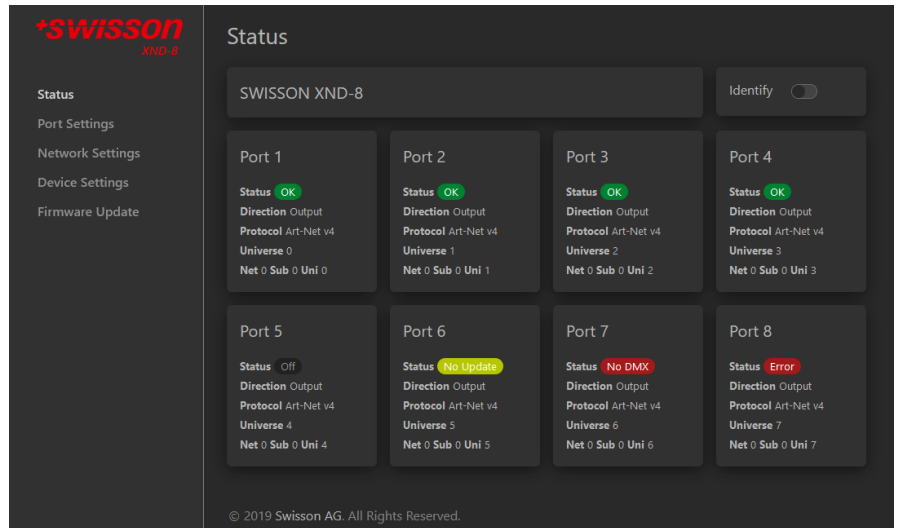

- **OK:** The port is receiving/transmitting successfully.
- **No Update:** Not receiving any updates on this universe for the last 10 seconds.
- **Off:** The port is currently disabled through settings made by the user.
- **No DMX:** The port is not receiving/transmitting any DMX.
- **Error:** The port is producing errors and requires user intervention.

Port Settings Page

On the port settings page each port can be configured individually, or changes can be applied to multiple ports at once. To configure the ports separately, select the number in the top menu first, after which changes can be made to the settings. Once the changes are made, they can be sent to the device by pressing the apply button.

More information on the port settings can be found on page 14.

When setting up multiple ports at the same time under the Setup tab, the user has the option to select which ports the changes should be applied to and choose to autoincrement the universe number along the ports that are being configured.

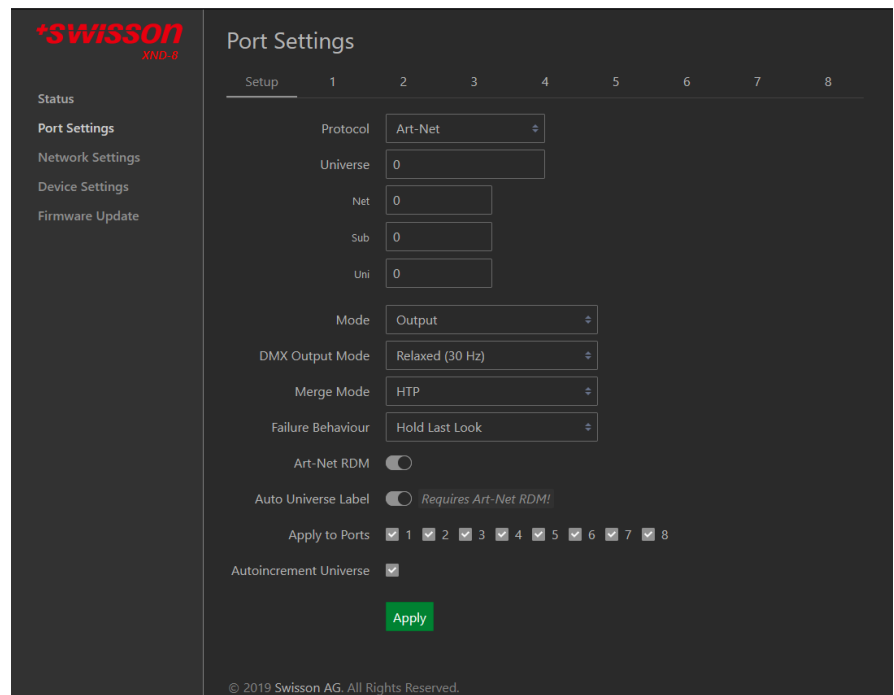

Network Settings Page

The network settings page enables the user to change network settings and see relevant information concerning the Ethernet port status.

For a detailed description of the network settings, please consult page 10 where they are described in detail.

Attention: Changes to the network settings could result in the device not being accessible via network! Use with caution!

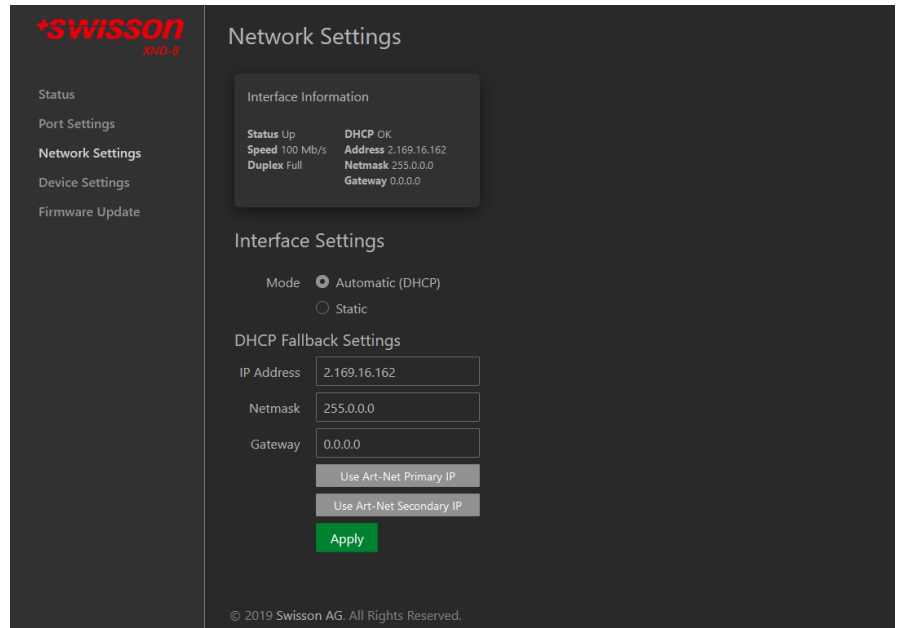

Device Settings Page

This page allows the user to view and make changes to any relevant device information. Furthermore, the factory defaults can be restored from here.

A detailed description of the device settings can be found on page 19.

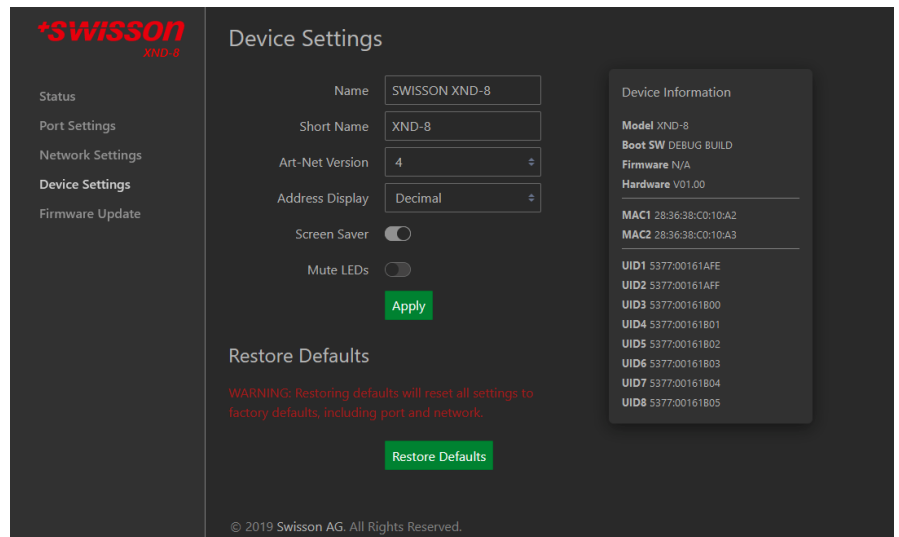

Firmware Update Page

From this page firmware updates can be performed. To do so, simply select the desired firmware file and then upload it. Additionally, this page informs you about the currently loaded firmware and the hardware version.

For more information on firmware updates, see page 25.

Browser Compatibility

The web interface is compatible with most current web browsers. For a detailed list of supported browser versions, please consult the appendix.

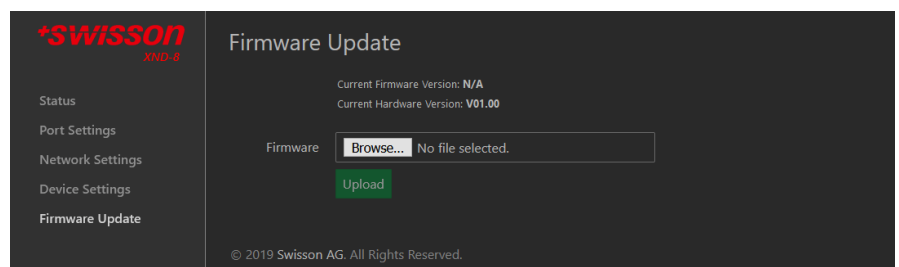

Technical Data

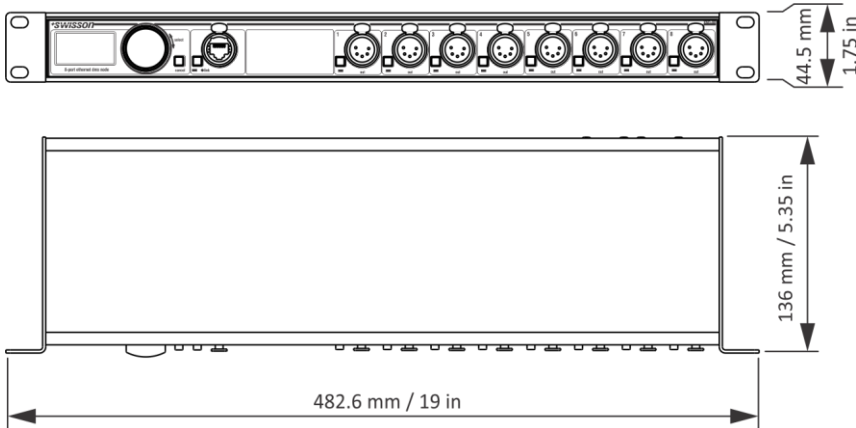

Ambient temperature	-30°C...55°C (-22°F...131°F)
AC power	100 - 240 V nominal, 50/60 Hz
Typical power consumption	10 W
Ethernet	10BASE-T / 100BASE-TX, auto negotiating, auto MDI-X
Network protocols	Art-Net 1-4, sACN (ANSI E1.31), sACN draft version (v0.2)
DMX.....	ANSI E1.11
RDM	ANSI E1.20
Electrical standard signal ports	EIA-485

Dimensions

Depth	136 mm (5.35 in)
Width	482.6 mm (19 in)
Height.....	44.5 mm (1.75 in)
Weight.....	1.8 kg (4 lb.)

Ordering Information

Standard Versions, Rack Mountable

10 48 30	XND-8R3	8-port Ethernet DMX node, rack mountable, 3-pin XLRs
10 48 31	XND-8R5	8-port Ethernet DMX node, rack mountable, 5-pin XLRs
10 48 32	XND-8R8	8-port Ethernet DMX node, rack mountable, RJ45 etherCON

Credits

LwIP

This product includes parts of lwIP which is licenced under the BSD licence:

Copyright (c) 2001-2004 Swedish Institute of Computer Science.

All rights reserved.

Redistribution and use in source and binary forms, with or without modification, are permitted provided that the following conditions are met:

1. Redistributions of source code must retain the above copyright notice, this list of conditions and the following disclaimer.
2. Redistributions in binary form must reproduce the above copyright notice, this list of conditions and the following disclaimer in the documentation and/or other materials provided with the distribution.
3. The name of the author may not be used to endorse or promote products derived from this software without specific prior written permission.

THIS SOFTWARE IS PROVIDED BY THE AUTHOR ``AS IS AND ANY EXPRESS OR IMPLIED WARRANTIES, INCLUDING, BUT NOT LIMITED TO, THE IMPLIED WARRANTIES OF MERCHANTABILITY AND FITNESS FOR A PARTICULAR PURPOSE ARE DISCLAIMED. IN NO EVENT SHALL THE AUTHOR BE LIABLE FOR ANY DIRECT, INDIRECT, INCIDENTAL, SPECIAL, EXEMPLARY, OR CONSEQUENTIAL DAMAGES (INCLUDING, BUT NOT LIMITED TO, PROCUREMENT OF SUBSTITUTE GOODS OR SERVICES; LOSS OF USE, DATA, OR PROFITS; OR BUSINESS INTERRUPTION) HOWEVER CAUSED AND ON ANY THEORY OF LIABILITY, WHETHER IN CONTRACT, STRICT LIABILITY, OR TORT (INCLUDING NEGLIGENCE OR OTHERWISE) ARISING IN ANY WAY OUT OF THE USE OF THIS SOFTWARE, EVEN IF ADVISED OF THE POSSIBILITY OF SUCH DAMAGE.

Art-Net

Art-Net™ Designed by and Copyright Artistic Licence Holdings Ltd

Appendix

Representations of Art-Net Port Addresses

According to the Art-Net 3 specification, the address of an Art-Net port consists of three parts: The Art-Net net, sub-net and universe number. The Art-Net universe and sub-net number both have a value between 0 and 15 (4 bits). Many controllers combine these values to the sub-uni number, resulting in a value between 0 and 255 (8 bits), with the sub-net part occupying the more significant digits. Thus, the sub-uni can be calculated with the formula $16 \times \text{sub-net} + \text{universe} = \text{sub-uni}$.

The Art-Net net number was added in Art-Net 3 and has a value between 0 and 127 (7 bits). So, when working with controllers using Art-Net I or Art-Net II, the Art-Net net must be set to 0.

The Art-Net net, sub-net and universe can be combined to a 15-bit port address with values from 0 to 32767, as shown below.

Bit Digit	14	13	12	11	10	9	8	7	6	5	4	3	2	1	0
Subdivided Representation	Net (0 - 127)						Sub-Net (0 - 15)				Universe (0 - 15)				
Alternative Representation	Net (0-127)						Sub-Uni (0 – 255)								
15-bit Port Address Rep.	(0 – 32767)														

For the instances where the Art-Net net number is 0, the 15-bit port address is equivalent to the sub-uni. The table below gives an overview of the entire Art-Net 3 address space and how it is converted to a 15-bit port address.

Art-Net Address			15-bit Port Address	Art-Net II addresses
Net (0 - 127)	Sub-Net (0 - 15)	Universe (0 - 15)		
0	0	0	0	
0	0	1	1	
...	
0	0	15	15	
0	1	0	16	
0	1	1	17	
...	
0	1	15	31	
0	2	0	32	
0	2	1	33	
...	
0	15	15	255	
1	0	0	256	
1	0	1	257	
....	
127	15	14	32766	
127	15	15	32767	
z	y	x	$z * 256 + y * 16 + x$	

Web Interface Compatible Browsers

The web interface was tested with following browsers.

Browser:	Version:
Chrome	80.0.3987.132
Firefox	73.0.1
Safari	13.1
Opera	67.0.3575.53
Edge	44.17763.831.0
Internet Explorer	11.1039.17763.0

No part of this documentation may be reproduced or transmitted in any form or by any means, electronic or mechanical, including photocopying and recording, without the prior written permission of Swisson AG.

The information in this documentation is supplied without warranty of any kind, either directly or indirectly, and is subject to change without prior written notice.

Swisson, its employees or appointed representatives will not be held responsible for any damages to software, hardware, or data, arising as a direct or indirect result of the product(s) mentioned herein.

26.08.2020

SWISSON AG
Fabrikstrasse 21
CH-3250 Lyss
Switzerland

SWISSON of AMERICA Corp.
2419 East Harbor Blvd.#3
Ventura, CA 93001
U.S.A.

E-Mail: welcome@swisson.com